

TEK.No	OMSCHRIJVING	FORMAAT	DATUM	-	A	B	C	D	E	F
	algemeen									
V-100	voorblad	A3	27-11-2020	●						
V-302	dubbele berging	hout	plat dak	A3	27-11-2020	●				
V-303	kwadrantberging	hout	plat dak	„	„	●				
V-305	enkele berging	hout	plat dak	„	„	●				

BAM Wooncollectie

bergingen

verkooptekeningen



Project	BAM Wooncollectie + Referentie		
onderwerp	voorblad	projectnr.	AE8485
	bergingen	tekeningnr.	V-100
schaal	1:50	status	definitief
		tekenaar	EOn
		(wijz)/datum	27-11-2020

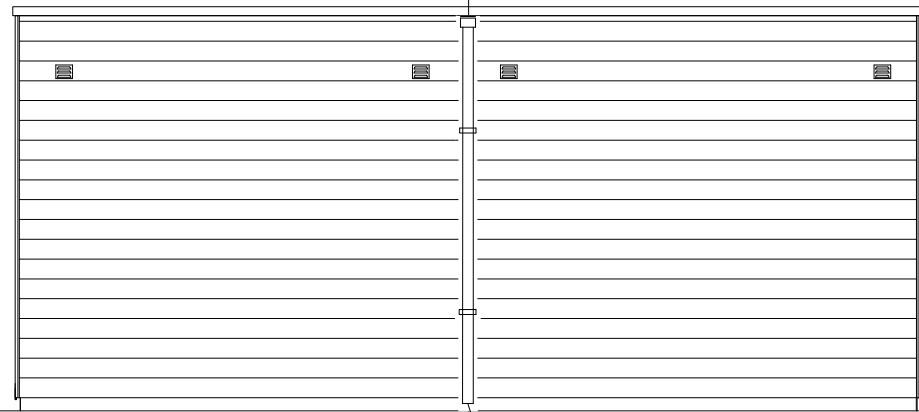

gevel tuinzijde

HWA lozing op grindput

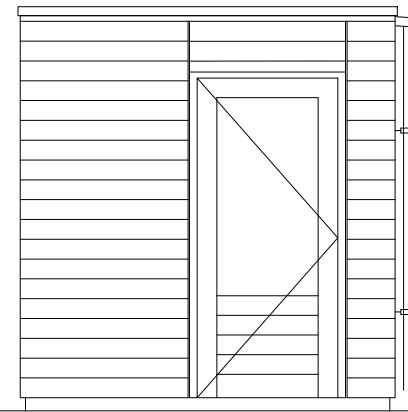

zijgevel Links

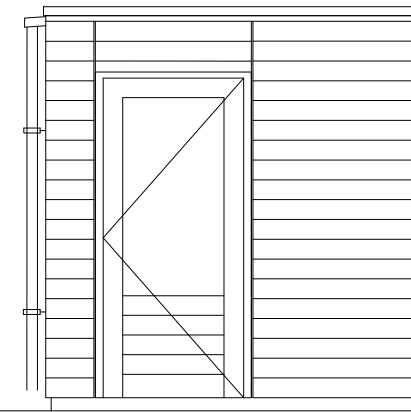

zijgevel Rechts

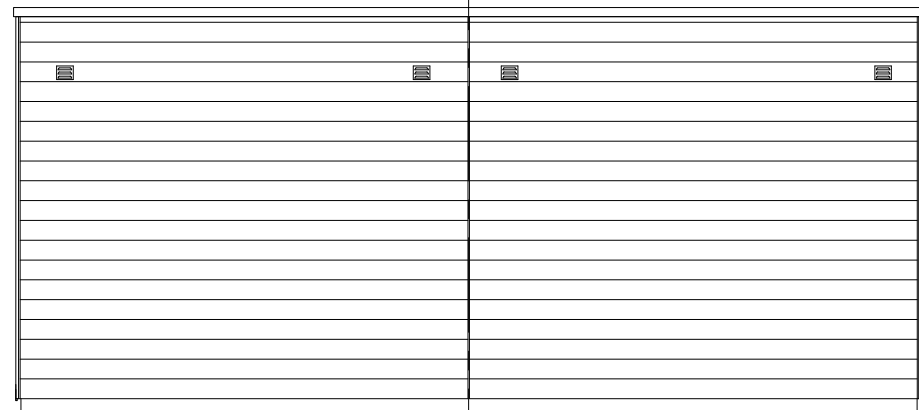

gevel achterpadzijde

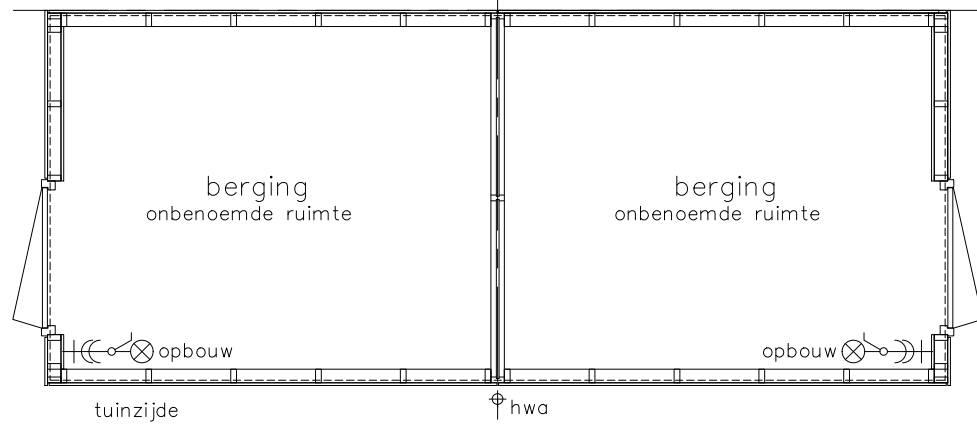

plattegrond

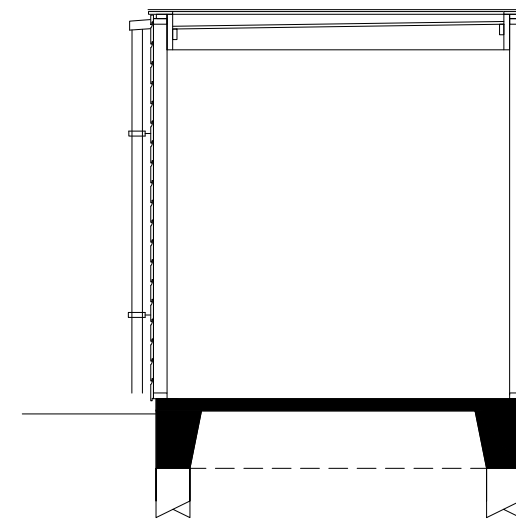

doorsnede "op palen"

opdrachtgever



Project BAM Wooncollectie + Referentie

projectnr. AE8485

tekeningnr.

V-302

(wijz)/datum 27-11-2020

onderwerp dubbele berging (hout)
plat dak

status definitief

tekenaar EOn

schaal 1:50

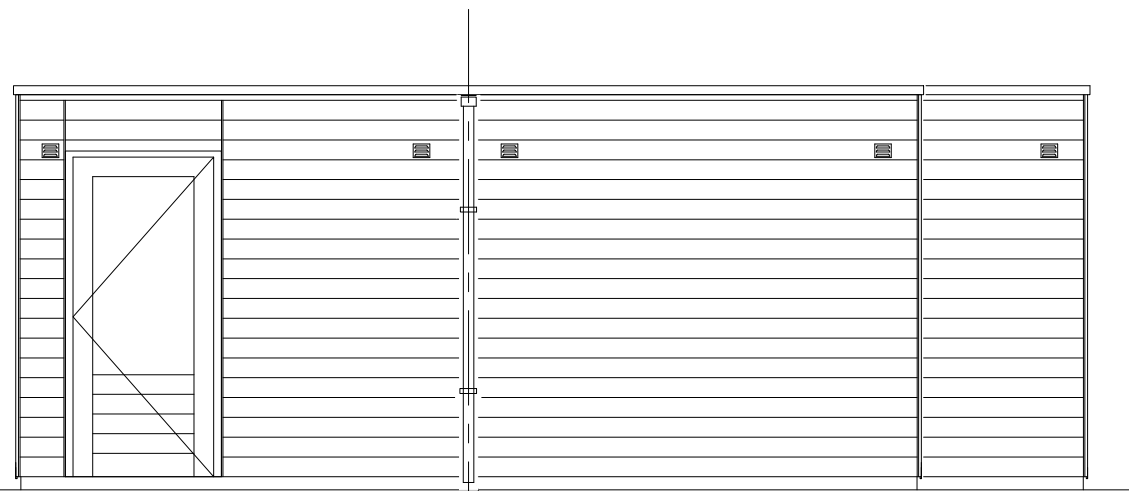

gevel tuinzijde bwnr. 5/6

HWA lozing op grindput

1100

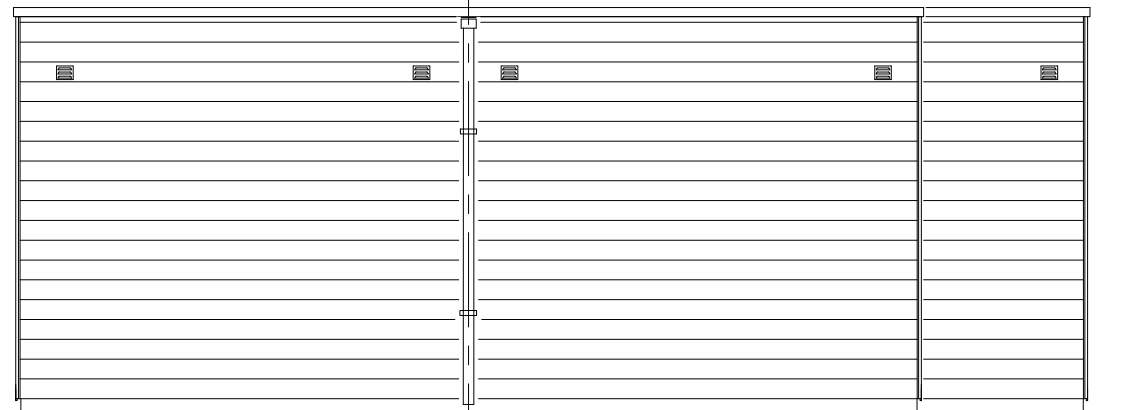

gevel tuinzijde bwnr. 17/18

1100

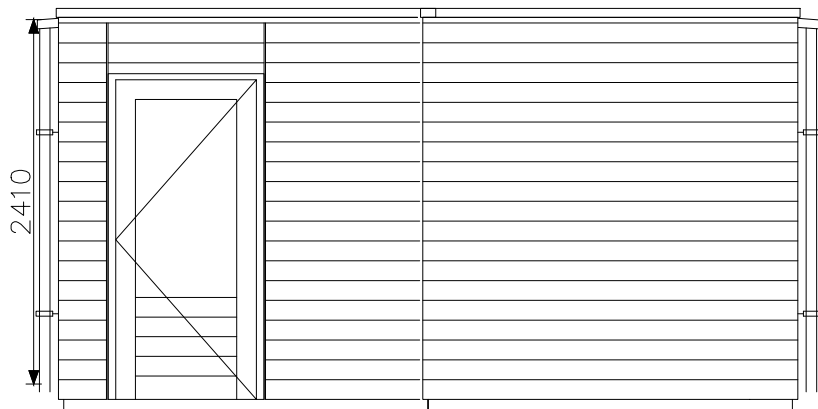

zijgevel Rechts

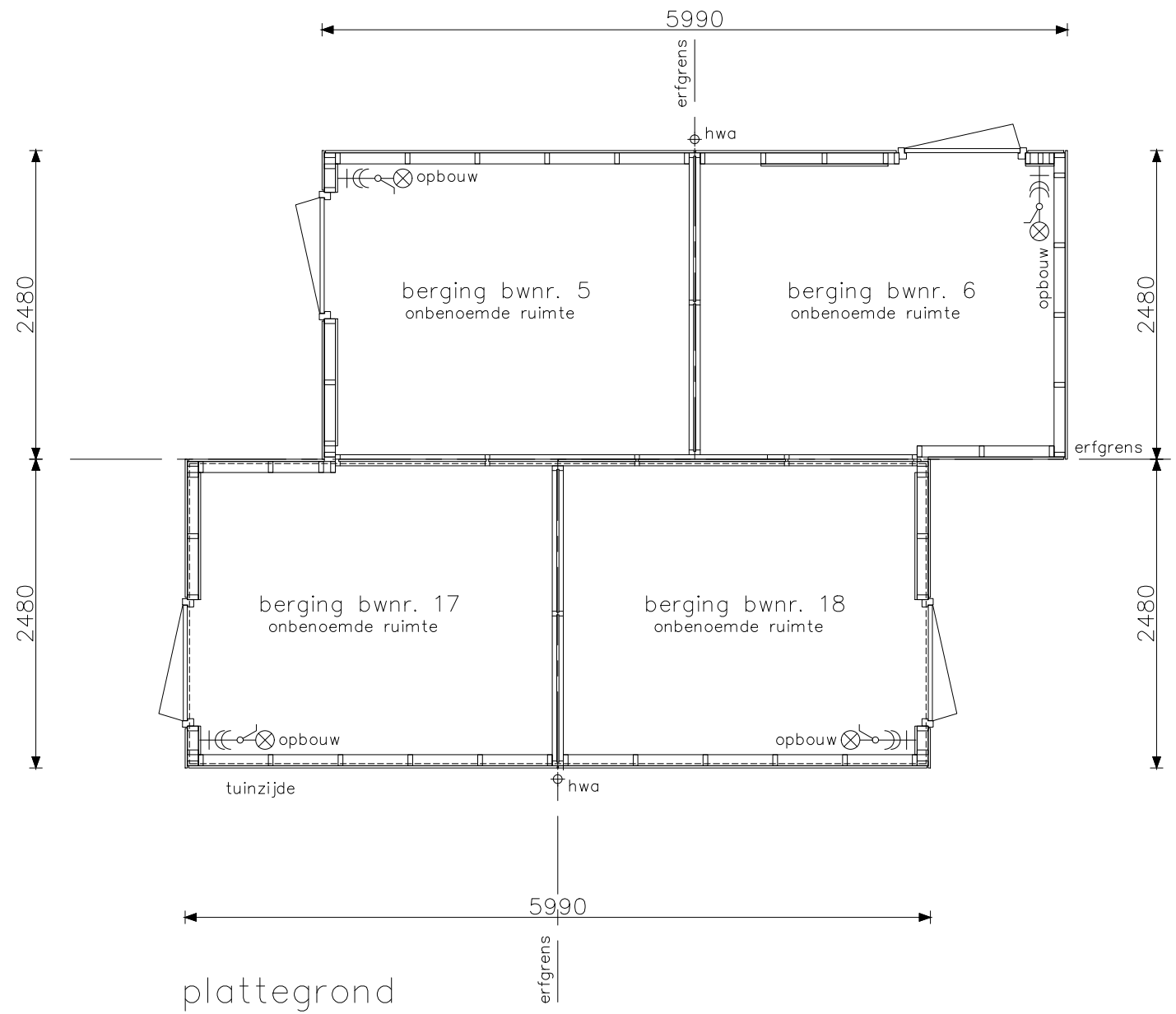

plattegrond

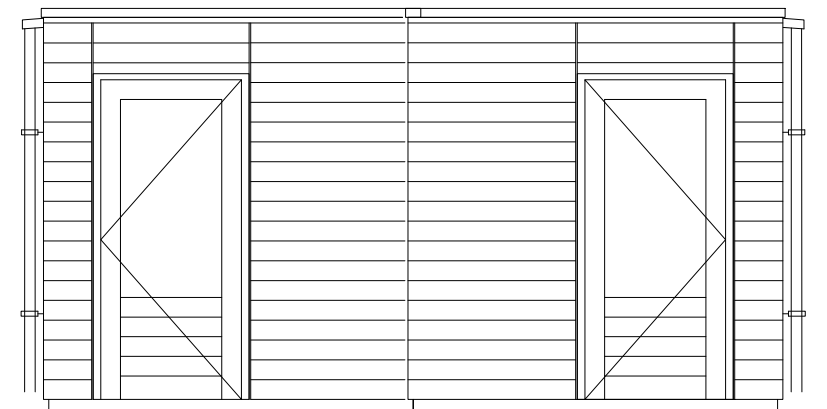

zijgevel Links

project		BAM Wooncollectie + Referentie	
onderwerp	kwadrantberging (hout) plat dak	projectnr.	AE8485
schaal	1:50	tekeningnr.	V-303
opdrachtgever	bam Wonen	tekenaar	EOn
		status	definitief
		wijzig./datum	27-11-2020

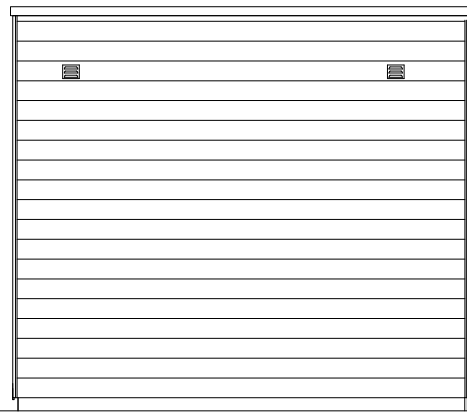

gevel achterpadzijde

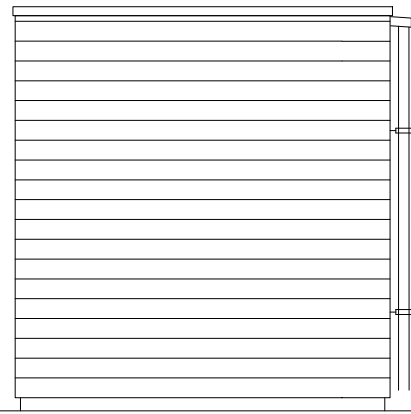

zijgevel Links

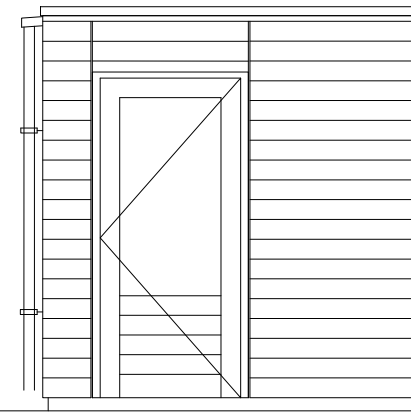

zijgevel Rechts

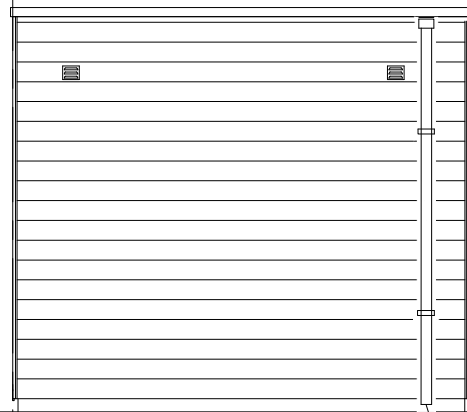

gevel tuinzijde

HWA lozing op grindput

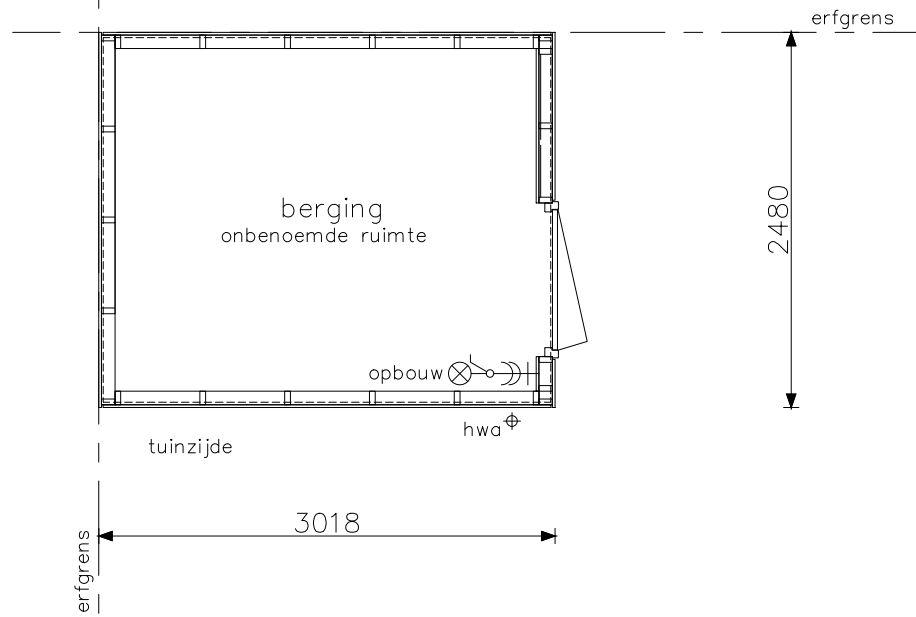

plattegrond

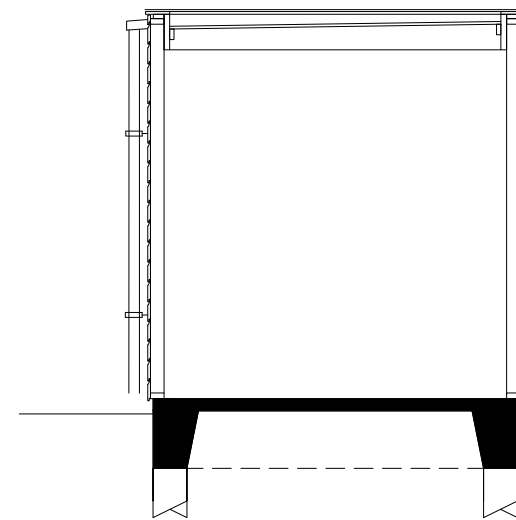

doorsnede "op palen"

Project		BAM Wooncollectie + Referentie	
onderwerp	enkele berging (hout) plat dak	projectnr.	AE8485
schaal	1:50	tekeningnr.	V-305
tekenaar	EOn	status	definitief
schrijver		wijzigingsnr.	27-11-2020

